

# PRODUCT SHEET

REV 0.0 - IT202504

## 6016 VIKING SHIP



ORGANIZATION WITH QUALITY MANAGEMENT SYSTEM  
 ISO 9001:2015 CERTIFIED by  
 EuCI European Certification Institute LTD  
 Certificate N.: GOTT2532Q1902

ORGANIZATION WITH ENVIRONMENTAL MANAGEMENT SYSTEM  
 ISO 14001:2015 CERTIFIED by  
 EuCI European Certification Institute LTD  
 Certificate No: GOTT2532E1801



SLIDING



CLIMBING





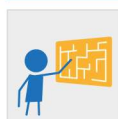



INTERACTIVE GAME

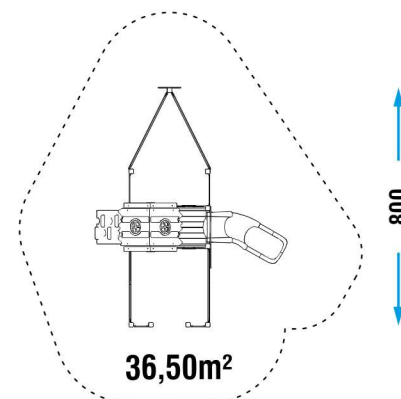

SECURITY AREA

700



	CATALOG COLLECTION	FUN COLLECTION
	<b>DIMENSIONS (L x W x H) in cm</b>	380 x 480 x 280 cm
	<b>IMPACT AREA</b>	36,50 m <sup>2</sup>
	<b>MAXIMUM CFH</b>	100 cm
	<b>SUGGESTED AGE OF USE</b>	3+
	<b>NUMBER OF USERS</b>	18

- COMPOSITION**
- n° 13 90x90 mm square section timber or aluminum structural posts
  - n° 2 decks with powder-coated metal frame
  - n° 1 HDPE sheet roofs with roto-molded PTE supports
  - n° 2 HDPE sheet and metal guard panels
  - n° 2 HDPE sheet guard panels
  - n° 1 roto-molded PTE modular slide (H100)
  - n° 1 roto-molded PTE climbing
  - HDPE sheet decorations

### PLAY PANELS

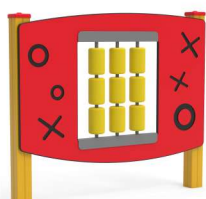

**LUDIC PLAY PANEL**  
**x1**



**EDUCATIONAL PLAY PANEL**  
**x1**

### INSTALLATION

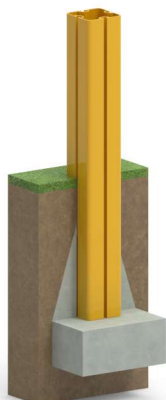

Where there is an aluminum pole, the plinth must be created directly on it.



If there is already an adequate fund in CLS the game can be supplied with special brackets for fixing to the ground (option applicable only with confirmation of feasibility).

Make a proper security surface according to CFH. Periodic maintenance is mandatory, following manual supplied to customer.

MATERIALE (mm) MATERIAL (mm)	DESCRIZIONE (mm) DESCRIPTION (mm)	PROFONDITÀ MINIMA (mm) (b) MINIMUM DEPTH (mm) (b)	ALTEZZA MASSIMA DI CADUTA (mm) CRITICAL FALL HEIGHT (mm)
PRATO/TERRICCIO LAWN/SOIL			1000 (d)
CORTECCIA BARK	PEZZATURA DA 20 A 80 20 TO 80 GRAIN SIZE	200	2000
		300	3000
TRUCIOLI DI LEGNO WOOD CHIPS	PEZZATURA DA 20 A 80 20 TO 80 GRAIN SIZE	200	2000
		300	3000
SABBIA SAND	PEZZATURA DA 20 A 80 20 TO 80 GRAIN SIZE	200	2000
		300	3000
GHIAIA GRAVEL	PEZZATURA DA 20 A 80 20 TO 80 GRAIN SIZE	200	2000
		300	3000
PAVIMENTAZIONE IN GOMMA RISPONDENTE A HIC RUBBER SURFACING RESPONDENT TO HIC	SPESSORE/THICKNESS	30mm	1000
		40mm	1300
		45mm	1500
		60mm	2000
		70mm	2500
		90mm	3000
			SOTTOPOSTA A PROVE DI CADUTA DEPENDENT ON CERTIFICATION TESTS